

CROSLLEY

Window Air Conditioner

USER MANUAL

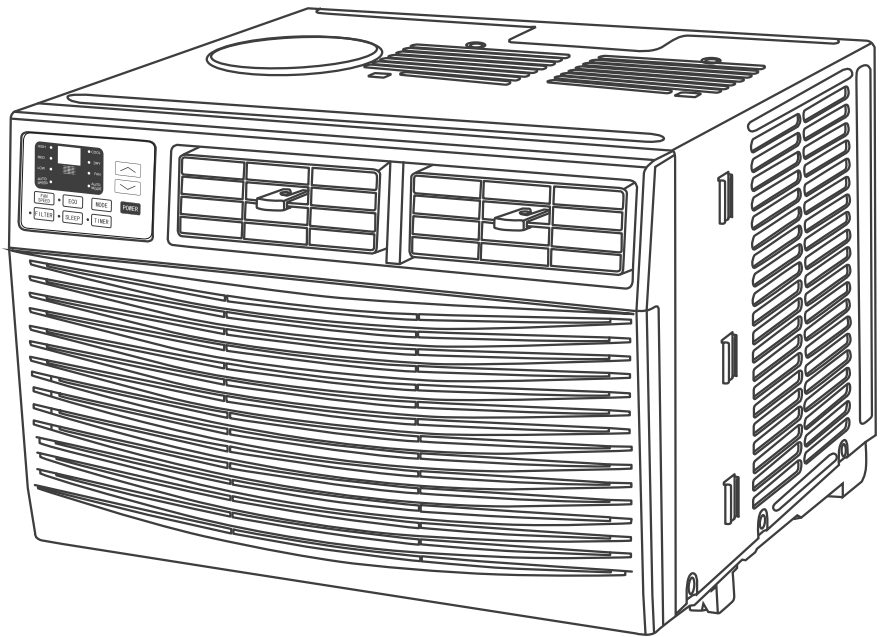

CATHE18A2

Customer Focused. Quality Driven.™

www.crosley.com

INTRODUCTION

IMPORTANT SAFETY INSTRUCTION	1
ELECTRICAL REQUIREMENTS	2
PACKING LIST	3
INSTALLATION&ASSEMBLY INSTRUCTIONS	4
USING YOUR AIR CONDITIONER	13
OPERATING YOUR AIR CONDITIONER	15
CARE AND CLEANING	16
TROUBLESHOOTING	17

IMPORTANT SAFETY INSTRUCTIONS

Before installing and using your air conditioner, please read this owner's manual carefully. Store this manual in a safe place for future reference. Your safety and the safety of others is very important to us. Please pay attention to all safety messages outlined in this owner's manual.

WARNING: To reduce the risk of fire, electrical shock or injury when using your air conditioner, follow the following basic precautions:

- Plug into a grounded 3 prong outlet.
- Do not remove the ground prong.
- Do not use a plug adapter.
- Do not use an extension cord.
- Unplug the air conditioner before servicing
- Use two or more people to move and install the air conditioner



This is a safety alert symbol.

This symbol alerts you to potential hazards that can harm you or others or even cause death.

All safety messages will directly follow the safety alert symbol and/or the words "DANGER" or "WARNING".

⚠ DANGER

⚠ WARNING

Failure to immediately follow these instructions may cause serious injury or even death.

All Safety messages alert you of potential hazards, how to reduce the chance of injury, and what can happen if instructions are not followed correctly.

ELECTRICAL REQUIREMENTS

⚠ WARNING



Electrical Shock Hazard

Plug into a grounded 3 prong outlet.

Do not remove the ground prong.

Do not use an adapter

Do not use an extension cord.

Failure to follow these instructions can result in death, fire, or electrical shock

The electrical ratings for your air conditioner are listed on the model and serial number label located on the front left side of the unit (when facing the front).

Specific electrical requirements are listed in the chart below. Follow the requirements below for the type of plug on the power supply cord.

Power Supply Cord

15K



18K/22K/24K



Recommended Ground Method

For your personal safety, this air conditioner must be grounded. This air conditioner is equipped with a 3 prong power supply cord with a grounded plug. To minimize the possibility of electrical shock, the cord must be plugged into a 3 prong outlet and grounded in accordance with all local codes and ordinances. If a 3 prong outlet is not available, it is the customer's responsibility to have a properly grounded 3 prong outlet installed by a qualified electrician.

It is the customer's responsibility:

- To contact a qualified electrician
- To assure that the electrical installation is adequate and in conformance with the National Electrical Code, ANSI/NFPA 70 - latest edition, and all local codes and ordinances.

Copies of the standards listed may be obtained from:

National Fire Protection Association

One Batterymarch Park

Quincy, Massachusetts 02269

LCDI Power Cord and Plug

This air conditioner is equipped with an LCDI (Leakage Current Detection and Interruption) power cord that is required by UL. This power supply cord contains state-of-the-art electronics that sense leakage current. If the cord is damaged and leakage occurs, power will be disconnected from the unit.

The test and reset buttons on the LCDI Plug are used to check if the plug is functioning properly. To test the plug:

1. Plug power cord into a grounded 3 prong outlet
2. Press RESET (on some units a green light will turn on).
3. Press the TEST Button, the circuit should trip and cut all power to the air conditioner (on some units a green light may turn off).
4. Press the RESET button for use. You will hear a click and the A/C is not ready for use.

NOTES:

- The RESET button must be engaged for proper use.
- The power supply cord must be replaced if it fails to trip when the TEST button is pressed and the unit fails to reset.
- Do not use the power supply cord as an ON/OFF switch. The power supply cord is designed as a protection device.
- A damaged power supply cord must be replaced with a new power supply cord.
- The power supply cord contains new user serviceable parts. Opening the tamper-resistant case voids all warranty and performance claims.

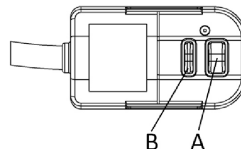











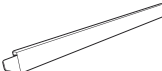





A. Reset button

B. Test button

NOTE: Your units power cord and plug may differ from the one shown.

PACKING LIST

IMAGE	PART	QUANTITY
	Window Air Conditioner	1
	Remote Control	1
	Top Mounting Rail (With sponge)	1
	Filler Panels (With "Left" & "Right" remark on the front face)	2
	Sash Lock(Two holes)	1
	Window Sash Seal (Sponge)	1
	5/16" Long Hex-head Screw	10
	5/8" Long Hex-head Screw	4
	1/2" Long Hex-head Screw	2
	5/8" Long Flat Head Bolt and Locknut	2ea
	Sill Angel Bracket	2
	1/2" Long Flat Head Bolt and Locknut	4ea
	Gasket	2
	Foam Top Window Gasket (Thin sponge for back-up using)	1
	Insulation strip(Sponge) (Only for E-star model)	2
	Support Bracket(with R and L remark)	2

DISCLAIMER

ALL INFORMATION AND THE TECHNICAL SPECIFICATIONS PRESENTED IN THIS USER'S MANUAL ARE THE PRESENTATION OF THE MANUFACTURER.

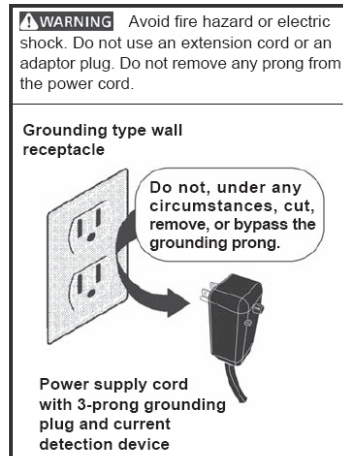

INSTALLATION & ASSEMBLY INSTRUCTIONS

Window Preparation

Please read all instructions prior to installing your air conditioner. Two people are recommended to install this product. If a new electrical outlet is required, have the outlet installed by a qualified electrician before installing the unit.

Before installing the unit, check the dimensions of your window to make sure the air conditioner will fit. This unit is made to fit inside a standard double-hung window. Make sure the window is in good shape and able to firmly hold the needed screws. If not, make repairs prior to installing the unit.

Model	15K/18K	22K/24K
Unit Height(inches)	17.91	18.625
Unit Width(inches)	23.625	26.50
Min. Window Opening (See FIG 1)(inches)	19.00	19.50
Min. Window Width (inches)	28.00	30.00
Max Window Width(inches)	41.00	41.00

Storm Window Requirements

A storm window frame will not allow the air conditioner to tilt properly which in turn will keep it from draining properly. To adjust for this, attach a board or piece of wood to the sill. The board or wood piece should have a depth of at least 1/2". Make sure the board or piece of wood is approximately 1/2" higher than the storm window frame. This will allow the air conditioner to tilt enough for proper drainage. (15K/18K See FIG.1/FIG.2 ; 22K/24K See FIG.3/FIG.4).

FIG.1

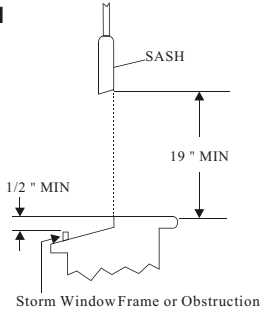
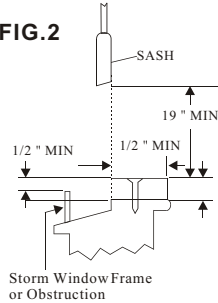

FIG.2



Board or wood piece must be approximately 1/2" higher than the storm window frame for proper drainage

FIG.3

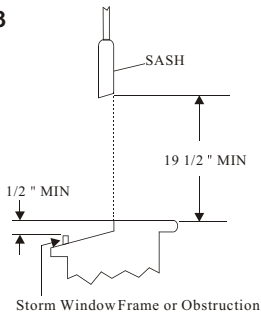
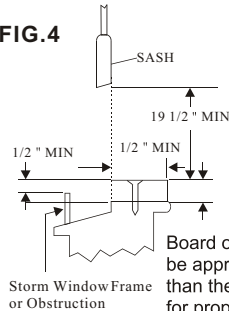

FIG.4



Board or wood piece must be approximately 1/2" higher than the storm window frame for proper drainage

Prior to Installing the Air Conditioner

1. Check for anything that could block airflow. Check the area outside of the window for things such as shrubs, trees, or awnings. Check the inside area to make sure curtains, drapes, or blinds will not prevent proper airflow.
2. Check the available electrical outlet. The power supply must be the same as shown on the unit serial nameplate (located on the left side of the unit, near the front faceplate). Be sure the outlet is close enough for the power cord to reach.
3. Carefully unpack the air conditioner. Remove all packing material and make sure the floor is protected when removing. Due to the large size of this air conditioner, two people should move the unit together.

CAUTION

When handling the unit, be careful to avoid cuts from the sharp metal edges and aluminum fins on the front and rear coils.

INSTALLATION & ASSEMBLY INSTRUCTIONS - WINDOW MOUNTING

REMOVE CHASSIS

1. Pull down the front panel and remove the filter (FIG.5 below)
2. Lift the front panel upwards to remove and place to the side.
3. Locate the four faceplate screws and remove. These screws will need to be re-installed prior to mounting the air conditioner (FIG.6 above)

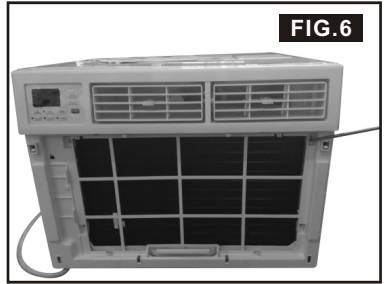

4. After removing the screws, gently pull away the faceplate from the air conditioner cabinet (FIG.7 & 8).
5. Remove the one control panel screws from the front panel (FIG.9).

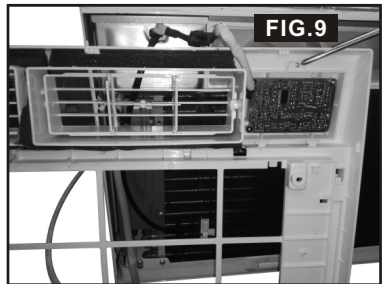

INSTALLATION & ASSEMBLY INSTRUCTIONS - WINDOW MOUNTING

REMOVE CHASSIS

6.Remove the six screws from the cabinet.(Every side for top,left and right has two screws.) (FIG.10)

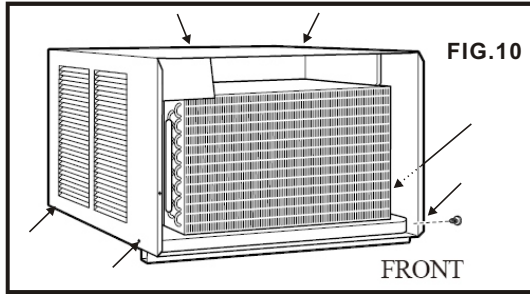

7. Hold the cabinet while pulling on the base handle to carefully remove the unit. Do not pull or lift near the top of the unit (FIG.11).

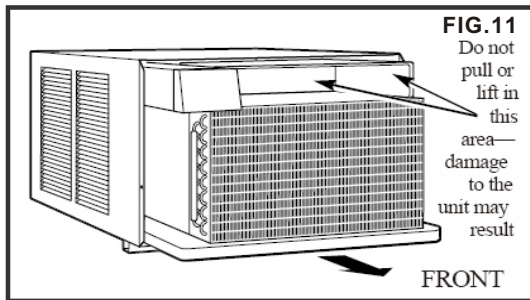

8.Take the pearl cotton for 24K(FIG.12).





ASSEMBLY & INSTALLATION (CONT.)

Top Angle Rail and Side Bracket Installation

The top rail must be assembled prior to installing the air conditioner in the window

Tools Needed: Phillips Screw Driver

Top Rail Hardware		QTY
	5/16" Long Hex-head Screw	4
	Top Rail	1

Attaching the Top Rail to the Air Conditioner

1. Remove the air conditioner from the box and place on a hard flat surface.

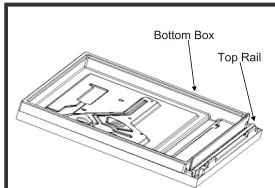

FIG. A

2. Remove top rail from the bottom of the packaging material as shown in FIG. A

Foam Gasket and Top Angle Rail

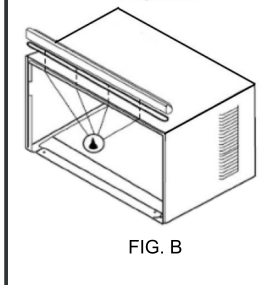
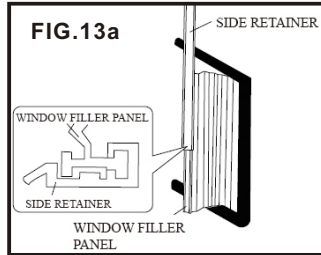

FIG. B

NOTE: For safety reasons, all 4 screws must be used to attach the top rail.

4. Slide the "I" section of the window panel into the side bracket of the cabinet (FIG.13a). Do this for both sides



5. Insert top and bottom legs of window filler panel frame into channel in the top angle and bottom rail. Do both sides. Install side retainer to cabinet as shown.FIG.13b-14.

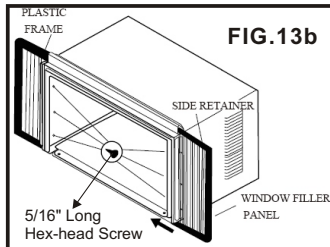

FIG.13b

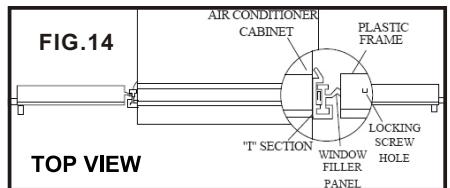
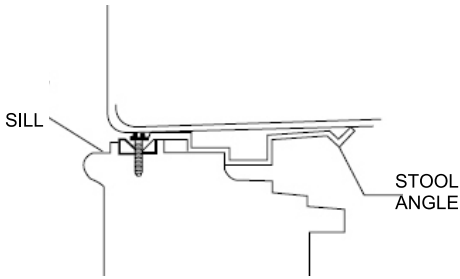

FIG.14

TOP VIEW

Placing the Cabinet Inside the Window

1. Open the window and place the cabinet in the middle of the window sill.
2. Make sure the bottom rail is seated over the window sill as shown below. Bring the window down temporarily behind the top angle rail to hold the cabinet in place. (Suggest to keep a downward oblique, to let accumulated rain water to drain out, from back side of the unit bottom.)



3. Fasten cabinet to window sill using two 5/8" Round-Head screws. Pre-drill holes if needed. Add the bottom rail seal over the screws.
(It should set on the gasket for 22K/24K)

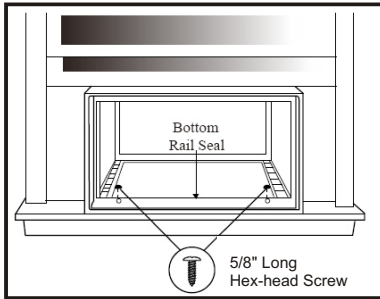

Install Support Brackets

1. Hold each support bracket flush against the outside of the window sill. Tighten each bracket to the bottom of the cabinet as shown below. Mark the brackets at top lever of the window sill and then remove.

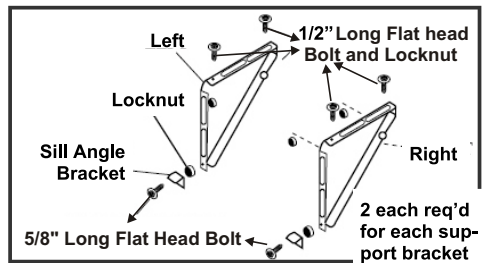
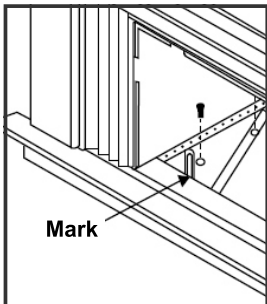

2. Assemble the sill angle brackets to the support brackets at the marked position as shown above. Hand tighten, but not all the way for any changes that may need to be made later during installation.
3. Install the support brackets (with sill angle brackets attached) to the bottom of the cabinet as shown below.
4. Tighten all 6 bolts securely.

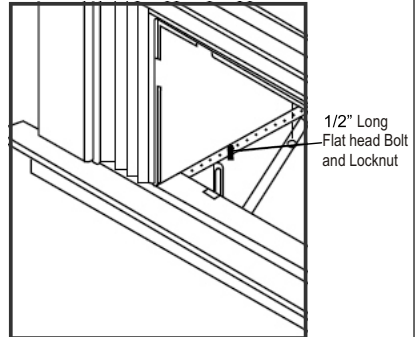

Extend the Accordion Panels

1. Carefully raise the window to expose the accordion panel and panel frame. Loosen the locking screws so

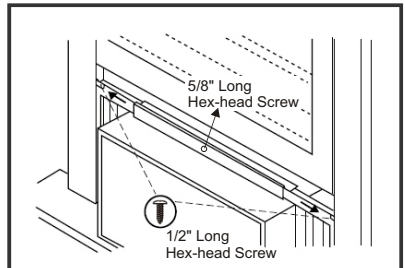

the accordion panels slide easily.

2. Extend each panel to completely fill the width of the window. Tighten the locking screws when the panels are fully extended.

ASSEMBLY & INSTALLATION (CONT.)

Install the Window Lock and Sash Seal

1. Trim the sash seal to fit the width of the window. Insert the sash seal into space between the upper and lower sashes.

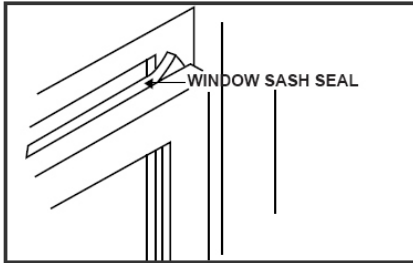

2. Attach the right angle sash lock as shown below.

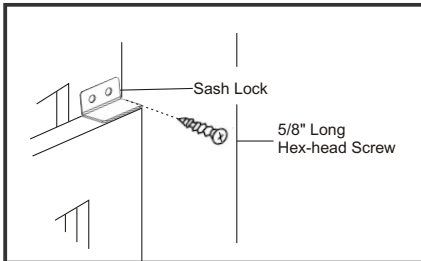

Installing the Chassis into the Cabinet

1. Team lift (two people) the air conditioner chassis and carefully slide it into the cabinet. Let the front of the air conditioner hang out approximately 6".
2. **CAUTION:** DO NOT PUSH ON THE CONTROLS OR FINNED COILS.
3. Be sure the chassis is firmly seated in the back of the cabinet.
4. Insert all screws removed during window installation and reattach the front face plate, front panel, and the air filter. Use the REMOVE CHASSIS instructions and figures 5-11 for reference.

THRU-THE-WALL INSTALLATION

NOTE: Consult local building codes prior to installation and/or a qualified carpenter.

Select the Wall Location

This air conditioner has a slide-out chassis, so that it can be installed through an outside wall as specified below:

MAX WALL THICKNESS: 8"

IMPORTANT: The side louvers must never be blocked.

NOTE: All parts needed for Thru-The-Wall Installation are provided, except a wood frame, shims, and 10 wood screws (10-1" long minimum). Select a wall surface that:

1. Does not support major structural loads such as the frame construction at ends of windows, and under truss-bearing points, etc.
2. Does not have plumbing or wiring inside.
3. Is near existing electrical outlets, or where another outlet can or will be installed.
4. Does not have objects blocking the air vents which limits cooling.
5. Allows unblocked airflow from the rear and sides of the air conditioner.

Prepare the Wall

1. Prepare the wall in frame construction (including brick and stucco veneer). Working from inside the room, find the wall stud that is nearest the center of the installation area.
2. Cut a hole on each side of the center stud.
3. Measure between the inside edges of every other stud as shown below.

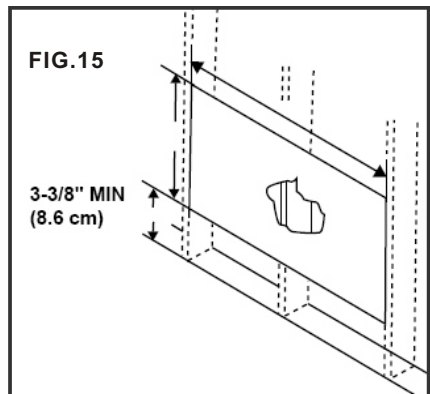

ASSEMBLY & INSTALLATION - THRU-THE-WALL (CONT.)

Carefully measure and cut an opening with the following dimensions depending on your model.

WIDTH "X" = inside model plus twice the thickness of the framing material used.

HEIGHT "Y" = inside model height plus twice the thickness of framing material used.

Model	15K/18K	22K/24K
Inside Frame Height	18 1/4 " (46.4 cm)	19 1/2 " (49.5 cm)
Inside Frame Width	23 7/8 " (60.6 cm)	26 9/10 " (68.3 cm)

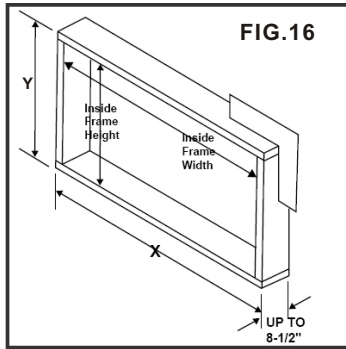

- Build a wooden frame with the INSIDE dimensions of your model listed above (Measure twice). The frame depth should be the same as the wall thickness. Fill in extra space from the opening to the studs with wood spacers as shown below.
- Nail the spacers to the studs. They should be flush with the dry wall.

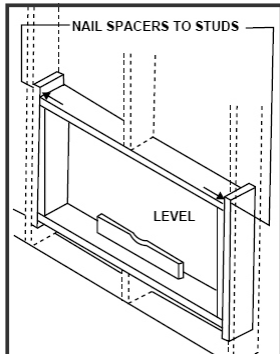

NOTE: If wall thickness is 8-1/2" or more, add aluminum flashing over the bottom of the frame opening to assure water is unable to enter the area between the inner and outer wall.

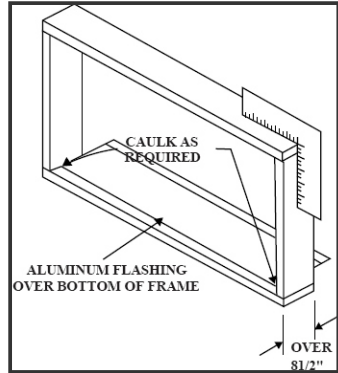

Prepare and Install the Cabinet

- Slide the chassis from the cabinet. Refer back to the REMOVE CHASSIS instructions (Page 6 and 7) in the WINDOW MOUNTING SECTION.
- Place the cabinet into the opening with the bottom rail resting firmly on the bottom board of the wood frame.
- Position the cabinet so it is tilted properly for water removal as seen below.

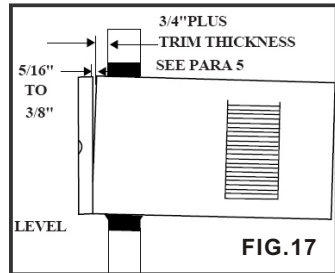

- Secure the bottom rail to the wood frame with two large 1" (2.5 cm) long wood screws as shown below.

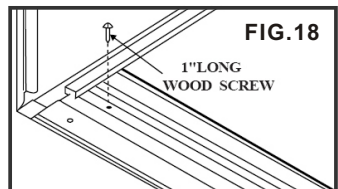

ASSEMBLY & INSTALLATION - THRU-THE-WALL (CONT.)

Refer to the SUPPORT BRACKET ASSEMBLY in the WINDOW MOUNTING section to assemble the support brackets. A wooden strip nailed to the outside wall should be used in conjunction with the angled sill support brackets.

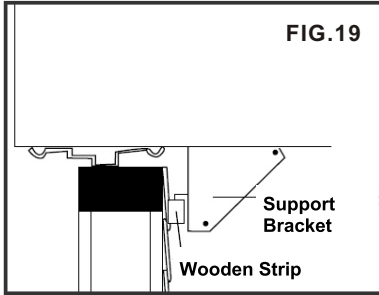

5. Screw or nail the cabinet to the wooden frame using shims if the frame is oversized, to eliminate possible noise. Remember to maintain proper slope for water elimination.

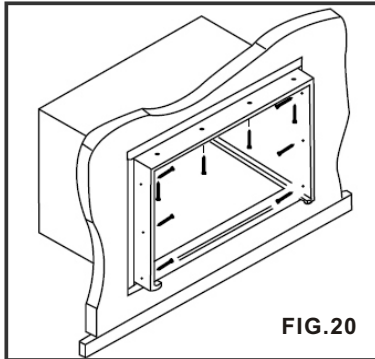

6. Install the chassis into the cabinet by following the steps described in the WINDOW MOUNTING section.

OPTIONAL: Caulking and installation of the trim on the interior wall may be done if desired. Caulk the openings around the top and sides of the cabinet and all sides of the wood sleeve to the opening.

NOTE: See the WINDOW MOUNTING instructions for the bottom rail seal location.

MASONRY CONSTRUCTION

1. Cut or build a wall opening in the masonry wall similar to the frame construction (refer to the THRU-THE-WALL installation for a wall thickness greater than 8 1/2").
2. Secure the cabinet in place using masonry nails, or masonry anchor screws. Or, build a frame using the instructions found in the THRU-THE-WALL installation section.
3. Make sure the masonry above the cabinet is supported well. Use the existing holes in the cabinet or additional drilled holes to fasten the cabinet at various positions. Make sure that the side louvers are clear of any obstructions.
4. Install the exterior cabinet support brackets according to the SUPPORT BRACKET INSTALLATION instructions in the THRU-THE-WALL installation section. Caulk or flash with aluminum if needed. This will provide a tight seal around the top and sides of the cabinet.
5. For a more aesthetically pleasing installation, apply wood trim molding around the sides of the cabinet without obstructing the side louvers.

USING YOUR AIR CONDITIONER

Electronic Control Panel & Remote Control

NOTE: This display always shows the room temperature in Fan Mode except when setting the Timer.

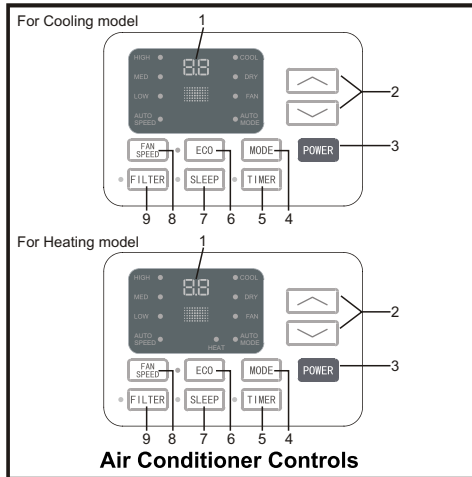

Air Conditioner Controls

Normal Operating Sounds

- You may hear a pinging noise caused by water hitting the condenser on rainy days, or when the humidity is high. This design feature helps remove moisture and improve efficiency.
 - You may hear the thermostat click when the compressor cycles on and off.
 - Water will collect in the base pan during rain or days of high humidity. The water may overflow and drip from the outside part of the unit.
 - The fan may run even when the compressor is not on.
- Digital Display:** Without timer setting, the set temperature will be displayed. Time will be displayed under the timer setting.
 - ^ And v Button:** Use these buttons on the control panel and remote to increase or decrease the Set Temperature or Timer. Temperature range: 61°F~88°F or 16°C~31°C.
 - Power Button:** Turn the air conditioner on and off.
 - Mode Button:** Press the mode button to cycle through the various modes: Cool, Dry, Fan and Auto, or Heat.

Cool Mode: The cooling function allows the air conditioner to cool the room and at the same time reduces air humidity. Press the MODE button to activate the cooling function. To optimize the function of the air conditioner, adjust the temperature and the speed by pressing the button indicated.

Dry Mode: This function reduces the humidity of the air to make the room more comfortable. Press MODE button to set the DRY mode. An automatic function of alternating cooling cycles and air fan is activated.

Fan Mode: The conditioner works in only ventilation. Press MODE button to set the FAN mode. With pressing the FAN SPEED button the speed changes in the following sequence: Hi, Med and Lo in FAN mode.

Auto Mode: In AUTO mode the unit automatically chooses the fan speed and the mode of operation (COOL, HEAT, DRY or FAN). In this mode the temperature are set automatically according to the room temperature (tested by the temperature sensor which is incorporated in the indoor unit.).

Heat Mode: The heating function allows the air conditioner to heat the room. Press the MODE button to activate the heating function. To optimize the function of the air conditioner, adjust the temperature and the speed by pressing the button indicated.

- Timer Button:** Use these buttons on the control panel and remote to set the Timer.

Timer Off: The timed stop is programmed by pressing TIMER button. Set the rest time by pressing the button “^” or “v” until the rest time displayed is to your liking then press the TIMER button again.

Timer On: When the unit is off, press TIMER button at the first time, set the temperature with pressing the button “^” or “v”. Press TIMER button at the second time, set the rest time with pressing the button “^” or “v”. Press TIMER button at the third time, confirm the setting, then the rest time to next automatical switching-on could be read on the display of the machine.

Note: It can be set to automatically turn off or on in 0.5-24 hours. Each press of the “^” “v” buttons will increase or decrease the timer. The Timer can be set in 0.5 hours increment below 10 hours and 1 hour increment for 10 hours or above. The SET light will turn on while setting.

To cancel the set function, press the TIMER button again.

USING YOUR AIR CONDITIONER

Electronic Control Panel & Remote Control

6. **ECO Button:** When the unit is in ECO mode, the light will turn on. In ECO mode, the unit will turn-off once the room is cooled to the user set temperature. The unit will turn back on when the room temperature rises above the user set temperature. Before the compressor starts, the fan motor will run for a while, then it will stop for awhile, It will repeat to provide a much more comfortable feeling and save energy.
7. **Sleep Button:** Press the SLEEP button, all the display lights will turn off after a while, but the Sleep Light is always on. In SLEEP mode, the air-conditioner will automatically adjust the temperature and fan speed to make the room more comfortable during the night. For cooling mode, the set temperature will automatically raise every 30-60 minutes and at most change six times until the set temperature is 81 or 82°F. For heating mode, the set temperature will automatically decrease every 30-60 minutes and at most change six times until the set temperature is 75 or 76°F. And every running time depends on the set temperature.
8. **Fan Speed Button:** Press the FAN SPEED button to choose the fan speed options. You can choose Hi, Med, Lo or auto speed in COOL mode and choose Hi, Med, Lo in FAN mode.
9. **Filter Button:** When the Filter Check light is off, it isn't necessary to press the Filter Check button. When the Filter Check light is on, you can turn off the light by pressing the Filter Check button. After the fan motor works for 500 total hours, the Filter Check light will turn on to remind the user to clean the filter.
10. **Directional Louvers:** To direct the airflow, use the horizontal wheel to control the horizontal direction and the air deflector to control the vertical direction.

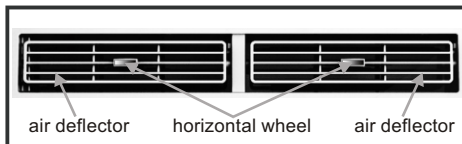

OPERATING YOUR AIR CONDITIONER

REMOTE CONTROL

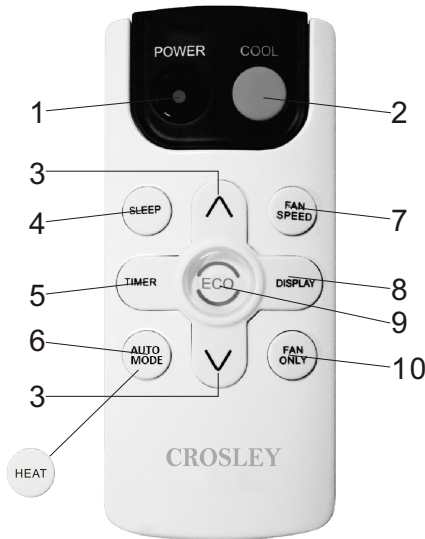

*For mark 6 button, it is AUTO MODE for cooling only, and it is HEAT for heating model.

1. Power: Turn the air conditioner on and off.
2. Cool: Press the COOL button to COOL mode.
3. \wedge and \vee : Use these buttons on the control panel and remote to increase or decrease the Set Temperature or Timer. Temperature range: 61°F~88°F or 16°C~31°C.
4. Sleep: Press the SLEEP button, the Sleep Light will be on after 10s, and all the left lights will be off. In SLEEP mode, the air-conditioner will automatically adjust the temperature and fan speed to make the room more comfortable during the night. The set temperature will automatically raise by 1 °C every 30-60 minutes and at most change six times until the set temperature is 28 °C. And every running time depends on the set temperature.
5. Timer: Use these buttons on the control panel and remote to set the Timer.
Timer Off: The timed stop is programmed by pressing TIMER button. Set the rest time by pressing the button “ \wedge ” or “ \vee ” until the rest time displayed is to your demand then press TIMER button again.
Timer On: When the unit is off, press TIMER button at the first time, set the temperature with pressing the button “ \wedge ” or “ \vee ”. Press TIMER button at the second time, set the rest time with pressing the button “ \wedge ” or “ \vee ”. Press TIMER button at the third time, confirm the setting, then the rest time to next automatical switching-on could be read on the display of the machine.
Note: It can be set to automatically turn off or on in 0.5-24 hours. Each press of the “ \wedge ” “ \vee ” buttons will increase or decrease the timer. The Timer can be set in 0.5 hours increment below 10 hours and 1 hour increment for 10 hours or above. The SET light will turn on while setting. To cancel the setted function, press the TIMER button again.
6. a. Auto Mode: In AUTO mode the unit automatically chooses the fan speed and the mode of operation (COOL, DRY or FAN). In this mode the fan speed and the temperature are set automatically according to the room temperature (tested by the temperature sensor which is incorporated in the indoor unit.). It is for cooling only model.
b. HEAT: Press the HEAT button to HEAT mode. It is for heating model.
7. Fan Speed: Press the FAN SPEED button to choose the fan speed options. You can choose Hi, Med, Lo or auto speed in COOL mode and choose Hi, Med, Lo in FAN mode.
8. Display: To press the DISPLAY button, it can switch off/on all lights or LED display.
9. Eco: When the unit is in ECO mode, the light will turn on. In ECO mode, the unit will turn-off once the room is cooled to the user set temperature. The fan will also be off at this point. The unit will turn back on when the room temperature rises above the user set temperature. Before the compressor starts, the fan motor will run for 20s, then it will stop for 10minutes -and will repeat to provide a much more comfortable-feeling and save energy.
10. Fan Only: Press the Fan Only button to FAN ONLY mode.

Battery Size: AAA - NOTE: Do not mix old and new batteries or different types of AAA batteries.

CARE AND CLEANING

Clean your air conditioner to keep it looking new and to minimize dust build up.

Air Filter Cleaning

The air filter should be checked at least once every month to see if it needs cleaning. Trapped particles and dust can build up in the filter and may decrease airflow as well as cause the cooling coils to accumulate frost. To clean the air filter:

1. Remove the filter by pulling down on the indent of the filter door on the front of the unit. (See FIG.21)
2. Wash the filter using liquid dish soap and warm water. Rinse the filter thoroughly. Gently shake the filter to remove excess water.
3. Let the filter dry completely before placing it into the air conditioner.
4. If you do not wish to wash the filter, you may vacuum the filter to remove the dust and other particles.

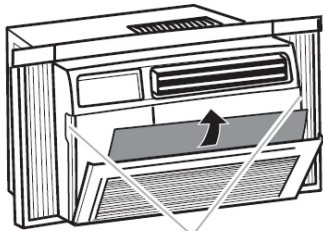

A
A. Indents

FIG.21

Wear and Tear

To minimize wear and tear on the air conditioner, always wait at least 3 minutes before changing modes. This will help prevent the compressor from overheating and the circuit breaker from tripping.

Cabinet Cleaning

To clean the air conditioner cabinet:

- Unplug the air conditioner to prevent shock or a fire hazard. The cabinet and front panel of the air conditioner may be dusted with an oil-free cloth or washed with a cloth dampened in a solution of warm water and mild liquid soap. Rinse thoroughly with a damp cloth and wipe dry.
- Never use harsh cleaners, wax or polish on the cabinet front.
- Be sure to wring excess water from the cloth before wiping around the controls. Excess water in or around the controls may cause damage to the air conditioner.

Winter Storage

To store the air conditioner when it is not in use for an extended period of time, remove it carefully from the window according to the installation instructions and cover it with plastic or place it in the original box.

TROUBLESHOOTING

PROBLEM	POSSIBLE CAUSES	SOLUTIONS
The Air Conditioner will not start	The air conditioner is unplugged	<ul style="list-style-type: none"> Make sure the air conditioner is plug is pushed completely into the outlet
	The fuse is blown/circuit breaker is tripped.	<ul style="list-style-type: none"> Check the house fuse/circuit breaker box and replace the fuse or reset the breaker.
	Power Failure	<ul style="list-style-type: none"> The unit will automatically re-start when power is restored. There is a protective time delay (approx. 3 minutes) to prevent tripping of the compressor overload. For this reason, the unit may not start normal cooling for 3 minutes after it is turned back on.
	The current interrupter device is tripped.	<ul style="list-style-type: none"> Press the RESET button located on the power cord plug. If the RESET button will not stay engaged, discontinue use of the air conditioner and contact a qualified service technician.
The Air Conditioner does not cool as it should	Airflow is restricted	<ul style="list-style-type: none"> Make sure there are no curtains, blinds, or furniture blocking the front of the air conditioner
	The temperature control may not be set correctly.	<ul style="list-style-type: none"> Lower the set thermostat temperature
	The air filter is dirty	<ul style="list-style-type: none"> Clean the filter. See the Cleaning and Care Section of the manual.
	The room may be too warm	<ul style="list-style-type: none"> Please allow time for the room to cool down after turning on the air conditioner.
	Cold air is escaping	<ul style="list-style-type: none"> Check for open furnace registers and cold air returns
	The Cooling Coils are frozen	<ul style="list-style-type: none"> See "Air Conditioner Freezing Up" below.
The Air Conditioner is freezing up	Ice blocks the air flow and stops the air conditioner from cooling the room	<ul style="list-style-type: none"> Set the MODE to HIGH FAN or HIGH COOL and set the thermostat to a higher temperature
The Remote Control is not working	The batteries are inserted incorrectly	<ul style="list-style-type: none"> Check the position of the batteries.
	The batteries may be dead	<ul style="list-style-type: none"> Replace the batteries

TROUBLESHOOTING (CONT.)

PROBLEM	POSSIBLE CAUSES	SOLUTIONS
Water is dripping outside	Hot and Humid weather.	<ul style="list-style-type: none">• This is normal
Water is dripping inside the room	The air conditioner is not correctly tilted outside.	<ul style="list-style-type: none">• For proper water drainage, make sure the air conditioner is slightly tilted downward from the front of the unit to the rear.
Water collects in the base pan	Moisture removed from the air is draining into the base pan.	<ul style="list-style-type: none">• This is normal for a short period in areas with low humidity and normal for a longer period in areas with high humidity.
Digital Display reads "E1", "E2"	A sensor has failed	<ul style="list-style-type: none">• Contact customer service

CROSLLEY

Your air conditioner is covered by a limited warranty provided by The Crosley Group (Crosley). Crosley has authorized CrosleyCare authorized servicers to perform the service under this warranty. Crosley authorizes no one else to change or add to any of these obligations under this limited warranty. Any obligations for service and parts under this limited warranty must be performed by an authorized CrosleyCare servicer. For one year from your original date of purchase, Crosley will pay all costs for repairing or replacing any parts of this appliance that prove to be defective in materials or workmanship when such appliance is installed, used and maintained in accordance with the provided instructions.

Crosley also offers our 10-year (including the 1-year period) Limited Major Component extended warranty which covers the compressor part if needed. Crosley Extended Warranty is the provider of this coverage. 800-356-5268

Please see warranty information packed with product or ask the dealer for complete limited warranty details.

Exclusions – This limited warranty does not cover the following:

1. Products with original serial numbers that have been removed, altered or cannot be readily determined.
2. Product that has been transferred from its original owner to another party or removed outside the USA.
3. Rust on the interior or exterior of the unit.
4. Products purchased "as-is".
5. Removal and/or installation of the product to provide service.
6. Products used in a commercial setting.
7. Service calls which do not involve malfunction or defects in materials or workmanship, or for appliances not in ordinary household use or used other than in accordance with the provided instructions.
8. Service calls to correct the installation of your appliance or to instruct you how to use your appliance.
9. Expenses for making the appliance accessible for servicing, such as removal of trim, cupboards, shelves, etc., which are not a part of the appliance when it is shipped from the factory.
10. Service calls to repair or replace appliance light bulbs, air filters, water filters, other consumables, or knobs, handles, or other cosmetic parts.
11. Surcharges including, but not limited to, any after hour, weekend, or holiday service calls, tolls, ferry trip charges, or mileage expense for service calls to remote areas, including the state of Alaska.
12. Damages to the finish of appliance or home incurred during installation, including but not limited to floors, cabinets, walls, etc.
13. Damages caused by: services performed by unauthorized service companies; use of parts other than genuine Crosley parts or parts obtained from persons other than authorized service companies; or external causes such as abuse, misuse, inadequate power supply, accidents, fires, or acts of God.

DISCLAIMER OF IMPLIED WARRANTIES; LIMITATION OF REMEDIES

CUSTOMER'S SOLE AND EXCLUSIVE REMEDY UNDER THIS LIMITED WARRANTY SHALL BE PRODUCT REPAIR OR REPLACEMENT AS PROVIDED HEREIN. CLAIMS BASED ON IMPLIED WARRANTIES, INCLUDING WARRANTIES OF MERCHANTABILITY OR FITNESS FOR A PARTICULAR PURPOSE, ARE LIMITED TO ONE YEAR OR THE SHORTEST PERIOD ALLOWED BY LAW, BUT NOT LESS THAN ONE YEAR. CROSLLEY SHALL NOT BE LIABLE FOR CONSEQUENTIAL OR INCIDENTAL DAMAGES SUCH AS PROPERTY DAMAGE AND INCIDENTAL EXPENSES RESULTING FROM ANY BREACH OF THIS WRITTEN LIMITED WARRANTY OR ANY IMPLIED WARRANTY. SOME STATES AND PROVINCES DO NOT ALLOW THE EXCLUSION OR LIMITATION OF INCIDENTAL OR CONSEQUENTIAL DAMAGES, OR LIMITATIONS ON THE DURATION OF IMPLIED WARRANTIES, SO THESE LIMITATIONS OR EXCLUSIONS MAY NOT APPLY TO YOU. THIS WRITTEN WARRANTY GIVES YOU SPECIFIC LEGAL RIGHTS. YOU MAY ALSO HAVE OTHER RIGHTS THAT VARY FROM STATE TO STATE.

If You Need Service

Keep your receipt, delivery slip, or some other appropriate payment record to establish the warranty period should service be required. If service is performed, it is in your best interest to obtain and keep all receipts.

Service under this warranty must be obtained by contacting CrosleyCare at the addresses or phone numbers below. This warranty only applies in the USA. Your appliance is warranted by Crosley / CrosleyCare.

Crosley authorizes no person to change or add to any obligations under this warranty. Obligations for service and parts under this warranty must be performed by CrosleyCare or an authorized service company. Product features or specifications as described or illustrated are subject to change without notice.

For Service Contact:

CrosleyCare Service
1-844-CROSLLEY (276-7539)
3 Sperry Road
Fairfield, NJ 07004



For Extended Warranty or other information contact:

Crosley Extended Warranty
1-800-356-5268
11430 Gravois Rd
St. Louis, MO 63126

www.crosley.com